

Sitzhöhe  
 Seat height  
 Hauteur du siège  
 Altezza del sedile  
 Altura del asiento  
 Zithoogte  
 Wysokość siedziska  
 Višina sedeža  
 Siddehøjde

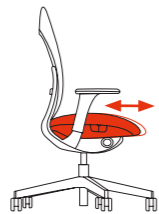

Sitztiefe  
 Seat depth  
 Profondeur du siège  
 Profondità del sedile  
 Profundidad del asiento  
 Zitdiepte  
 Głębokość siedziska  
 Nastavitev globine  
 Siddedybde

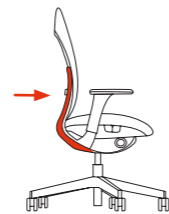

Rücken anpressdruck  
 Contact pressure  
 Pression d'appui  
 Pressione d'appoggio  
 Presión del respaldo  
 Contactdruk  
 Siła nacisku pleców  
 Hrbtno naslonjalo-pritisk  
 Rygstøttetryk

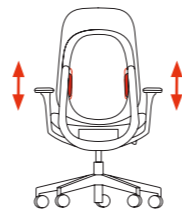

Lordosenstütze  
 Lumbar support  
 Soutien lombaire  
 Supporto lombare  
 Soporte lumbar  
 Lendensteun  
 Wsparcie lędźwi  
 Bederní opěrka  
 Lændestøtte



Sitz- und Rücken neigung  
 Seat and back inclination  
 Inclinaison du siège et du dossier  
 Inclinazione del sedile et dello schienale  
 Inclinación asiento y respaldo  
 Zit- en rugneiging  
 Odchylenie siedziska i oparcia  
 Naklon sedeza in naslonjala  
 Sæde- og rygstøtthældning

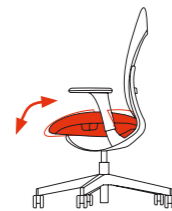

Vorwärtsneigung  
 Forward tilt  
 Inclinaison en avant  
 Inclinazione in avanti  
 Inclinación hacia delante  
 Voorwaartsneiging  
 Pochylenie do przodu  
 Naklon naprej  
 Hældning fremad

## giroflex 40

Bedienungsanleitung  
 User guide  
 Mode d'emploi  
 Istruzioni per l'uso  
 Instrucciones de uso  
 Gebruiksaanwijzing  
 Instrukcja obsługi  
 Navadilo za uporabo  
 Betjeningsvejledning

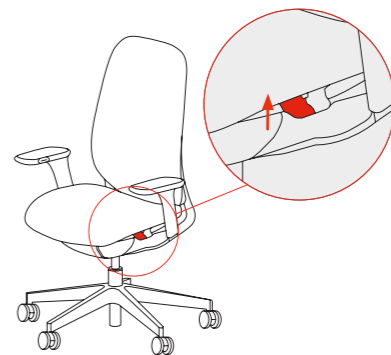
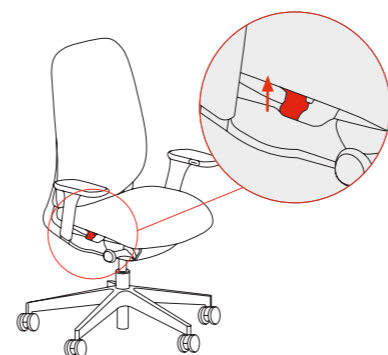
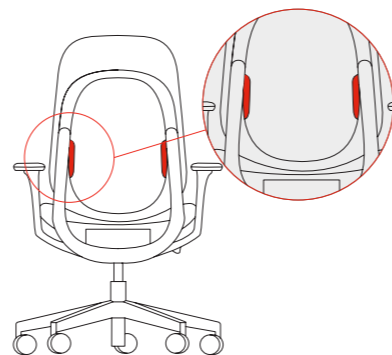
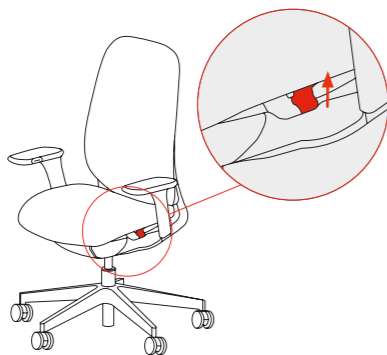
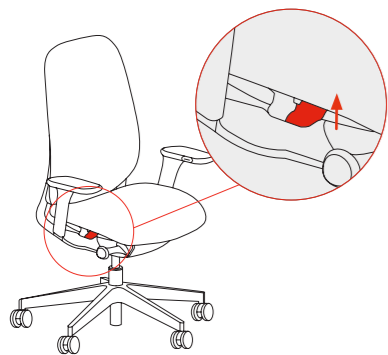

Optionen  
Options  
Options  
Opzioni  
Opciones  
Opties  
Opcje  
Možnosti  
Alternativer

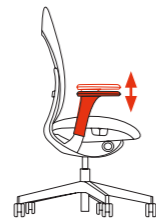

Armlehnenhöhe  
Armrest height  
Hauteur des accoudoirs  
Altezza dei braccioli  
Reposabrazos altura  
Armléuningbreedte  
Wysokość podłokietników  
Naslon za roke-višine  
Armlænhojðe

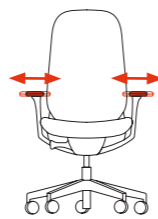

Armlehnenbreite  
Armrest width  
Largeur des accoudoirs  
Larghezza dei braccioli  
Reposabrazos anchura  
Armléuninghoogte  
Szerokość podłokietników  
Naslon za roke-širina  
Armlænbreidde

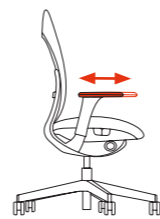

Armlehntiefe  
Armrests depth  
Profondeur des accoudoirs  
Profondità dei braccioli  
Reposabrazos profundidad  
Armléuningdiepte  
Głębokość podłokietników  
Naslon za roke-globina  
Armlændybde

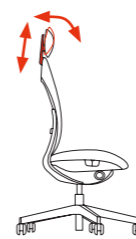

Kopfstützenhöhe- und -Neigung  
Headrest height and inclination  
Hauteur et inclinaison de l'appui-tête  
Altezza e inclinazione del poggiatesta  
Apoyacebas altura e inclinación  
Hoofdsteunhoogte en hellingshoek  
Wysokość i nachylenie zagłówek  
Višina in nagib naslonjala za glavo  
Nakkestøtte højde og vinkel

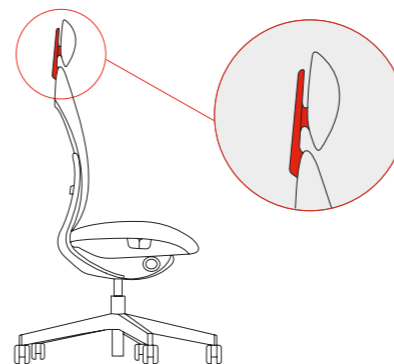

Mehr Details  
More details  
Plus de détails  
Più dettagli  
Más detalles  
Meer details  
Więcej informacji  
Více informací  
Mere informasjon



Flokk AG  
Alpenstrasse 3  
8152 Opfikon

+41 (0) 56 267 91 11  
info-ch@flokk.com  
www.flokk.com

09.2023

## giroflex 40

Bedienungsanleitung  
User guide  
Mode d'emploi  
Istruzioni per l'uso  
Instrucciones de uso  
Gebruiksaanwijzing  
Instrukcja obsługi  
Navadilo za uporabo  
Betjeningsvejledning